

# CAZ=BOO

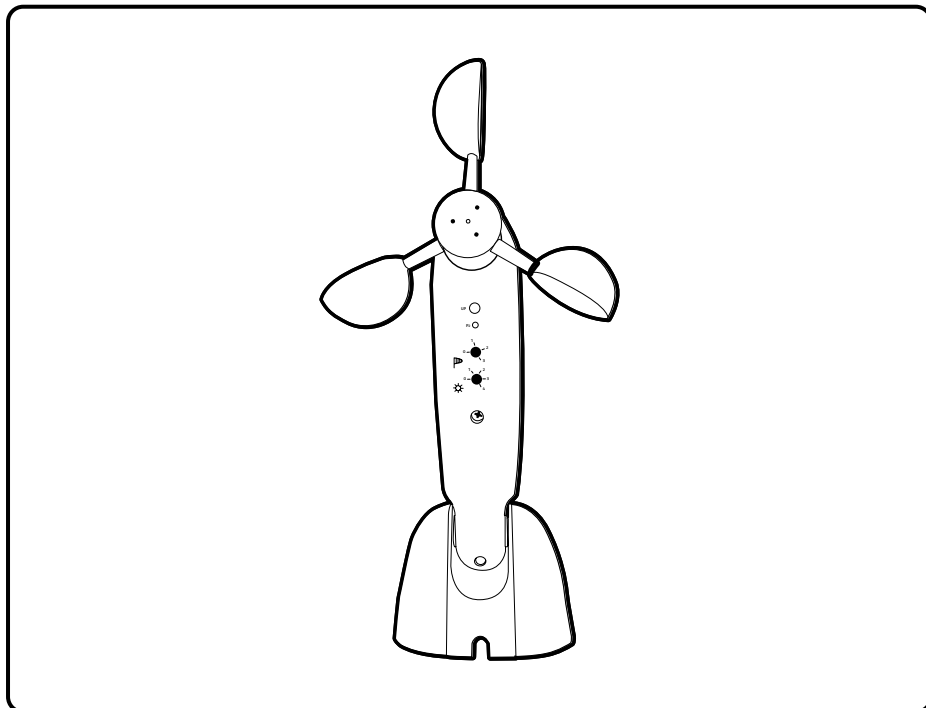

EN FR DE ES PT IT NL PL FI SE DK 

INSTRUCTION MANUAL / NOTICE DE MONTAGE / MONTAGEANLEITUNG / MANUAL DE MONTAJE / MANUAL DE MONTAGEM  
/ MANUALE DI MONTAGGIO / MONTAGEHANDLEIDING / INSTRUKCJA MONTAŻU / KÄYTTÖOHJEET / BRUGSANVISNING /  
BRUGSANVISNING

✘

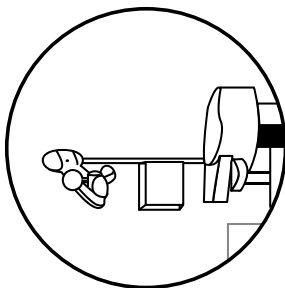

✔

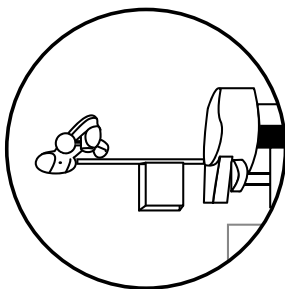

✘

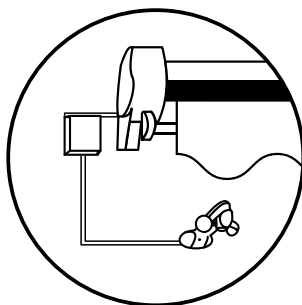

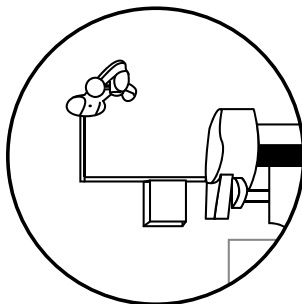

✔

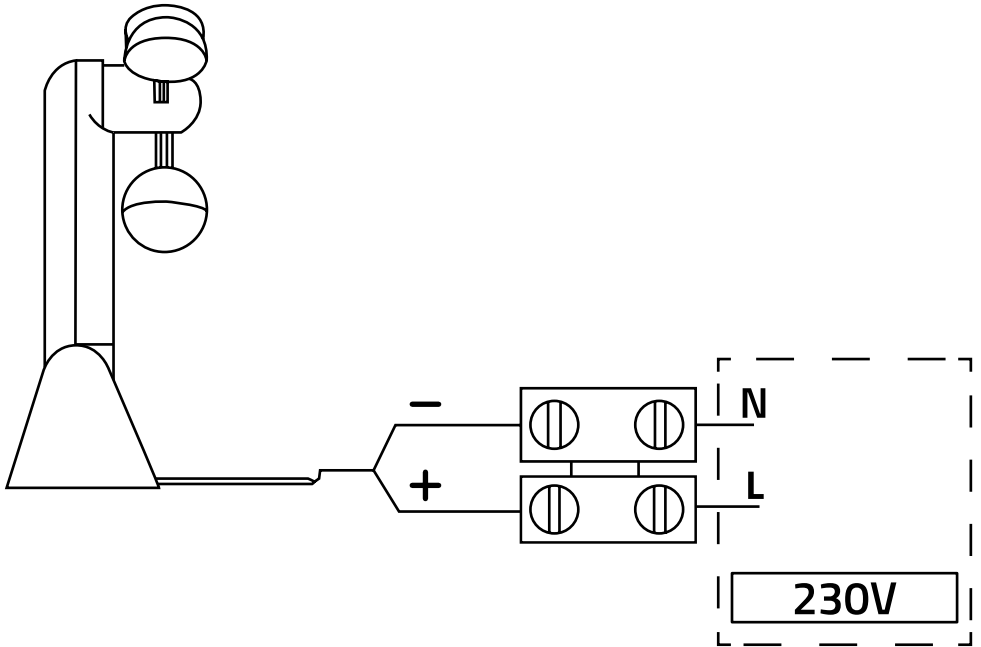

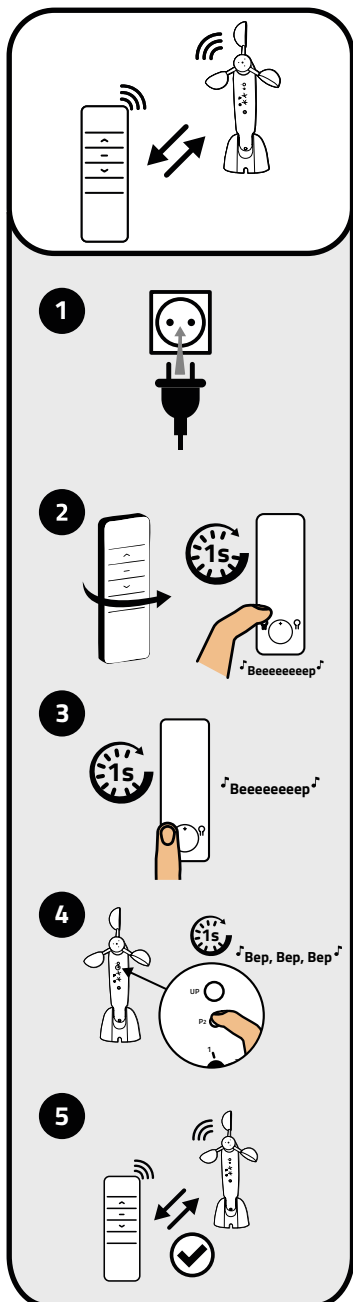



	
0	10 km/h
1	20 km/h
2	30 km/h
3	40 km/h

	
1	15K LUX
2	30K LUX
3	45K LUX
4	60K LUX

**EU DECLARATION OF CONFORMITY**

DECLARATION DE CONFORMITE EU / DECLARACIÓN DE CONFORMIDAD UE / EU-KONFORMITÄTSEKLRÄRUNG /  
DICHIARAZIONE DI CONFORMITÀ UE / EU-CONFORMITEITSVERKLARING

Technical report numbers : 709502230023-01 / 704102230023-01 / 704102406168-00 / 180312542a-001

**Hoortrade SAS**  
**83-85 Bd du Parc d'Artilerie, 69007 Lyon, France**

**Declares that the following product:**

*Déclare que le produit suivant / Declara que el siguiente producto / Es wird erklärt, dass das folgende Produkt / Dichiaro che il seguente prodotto*

**SKU: DC8810**

**HOORTRADE reference :**

*Référence HOORTRADE / Referencia HOORTRADE / HOORTRADE-Referenz / Riferimento HOORTRADE*

**STI-000352**

**Satisfies the essential requisities established in following directives :**

*Satisfait aux exigences essentielles établies dans les directives suivantes :*  
*Cumple los requisitos esenciales establecidos en las siguientes directivas:*  
*Erfüllt die in den folgenden Richtlinien festgelegten wesentlichen Anforderungen:*  
*Soddisfa i requisiti essenziali stabiliti nelle seguenti direttive:*

**Radio equipment directive (RED) - 2014/53/EU**

**RoHS directive - 2011/65/EU+2015/863+2017/2102**

**Complies with applicable harmonised standards and/or technical specifications :**

*Est conforme aux normes harmonisées et/ou spécifications techniques applicables:*  
*Cumple las normas armonizadas y/o especificaciones técnicas aplicables:*  
*Entspricht den geltenden harmonisierten Normen und/oder technischen Spezifikationen:*  
*E conforme alle norme armonizzate e/o alle specifiche tecniche applicabili:*

**EN 301 489-1 V2.2.3:2019 ; EN 301 489-3 V2.1.1:2019**  
**EN 300 220-2 V3.1.1:2017**  
**EN 50663:2017**  
**EN 60730-1:2011 ; EN 62479:2010**  
**EN 63000:2018**

Manufacturer also declares that it is not permitted for the abovementioned components to be used such time as the system in which they are incorporated is declared conform to European directive. Any modification made on the machine without our prior acceptance is making this declaration not valid.

*Le fabricant déclare également qu'il n'est pas permis d'utiliser les composants susmentionnés tant que le système dans lequel ils sont incorporés est déclaré conforme à la directive européenne. Toute modification apportée à la machine sans notre accord préalable rend cette déclaration non valable.*

*El fabricante declara asimismo que no está permitido el uso de los componentes mencionados hasta que el sistema en el que se incorporan se declare conforme a la directiva europea. Cualquier modificación realizada en la máquina sin nuestra aceptación previa hace que esta declaración no sea válida.*

*Der Hersteller erklärt außerdem, dass die Verwendung der oben genannten Bauteile nicht zulässig ist, solange das System, in das sie eingebaut sind, als konform mit der europäischen Richtlinie erklärt wird. Jede Änderung an der Maschine, die ohne unsere vorherige Zustimmung vorgenommen wird, macht diese Erklärung ungültig.*

*Il fabbricante dichiara inoltre che non è consentito l'uso dei suddetti componenti nel momento in cui il sistema in cui sono incorporati viene dichiarato conforme alla direttiva europea. Qualsiasi modifica apportata alla macchina senza la nostra preventiva accettazione rende questa dichiarazione non valida.*



Name of signator : CHARPE  
Position : PRESIDENT  
Done in Lyon, 25 november 2024